



WILLIAM JOHNSTON
& COMPANY LIMITED



GPT



Glasgow Tel: +44 (0) 141 620 1666 | Inverness Tel: +44 (0) 1463 238 673
sales@williamjohnston.co.uk | www.williamjohnston.co.uk

YOUR OFFICIAL UK DISTRIBUTOR FOR LINK-SEAL

Pipeline Accessories

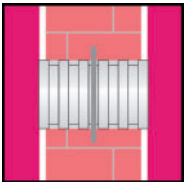

PSI Wall Sleeves

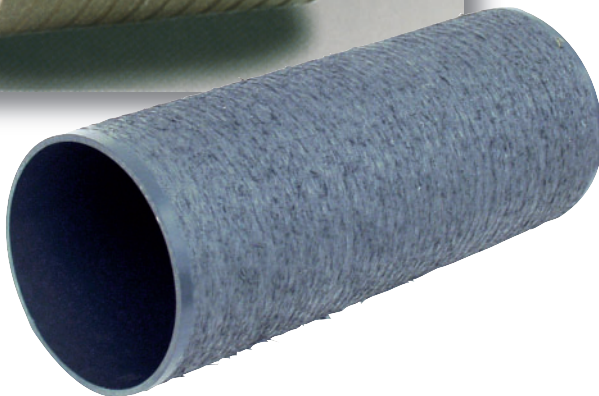

PSI Wall Sleeves made of steel

General Information

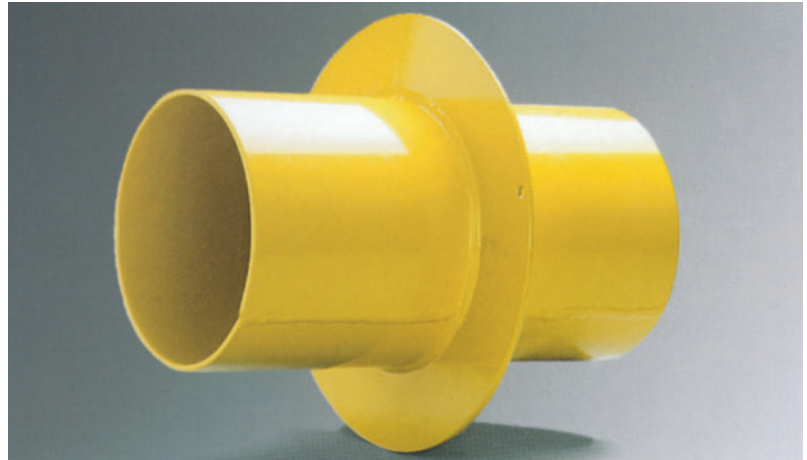

An economic method to seal hydrostatically

When passing steel, cast iron, copper or plastic pipes through walls, ceilings or floors, PSI sleeves are the best method to form a perfect hole in the wall.

Wherever the Link-Seal® modular seal is used to seal the annular space between the carrier pipe and the wall duct, the PSI sleeve is an essential item.

PSI sleeves are made of welded or seamless steel pipes. These can be supplied in galvanised or bare steel to protect against corrosion.

Other corrosion protection methods are available on request (e.g. electrostatic powder coating). Sleeves can also be made of special steel.

The standard PSI sleeve is supplied with a welded-on anchor flange. This acts as an annular water-stop plate which ensures 100 % sealing and also serves as a wall anchor.

Sleeve diameters are selected to suit the respective pipe and Link-Seal® modular seal.

Please specify in your sleeve order

When ordering PSI sleeves, please specify dimensions for D, L, L₁, the outside diameter of the carrier pipe to be passed through, and the desired Link-Seal® modular seal type.

Example: PSI sleeve 168.3 x 4 (D = sleeve O.D.)
300 (L = sleeve length in mm)
150 (L₁ = flange arrangement)

Available sizes are indicated in the price list. Split version on request.

Technical changes reserved.

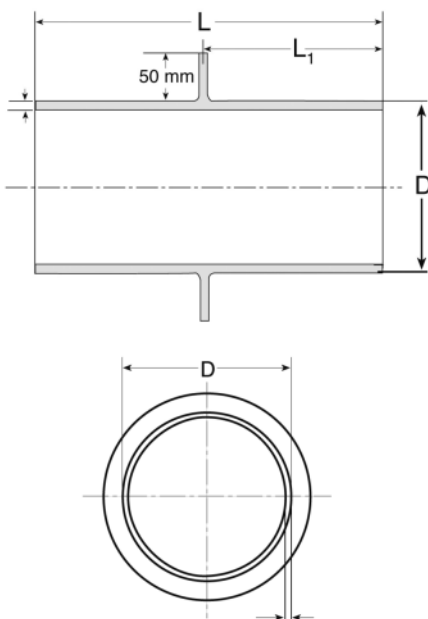



An economic and secure method to seal hydrostatically

PSI asbestos-free fibre cement wall sleeves are - in connection with PSI Link-Seal® or Kompakt seals - the right accessory to form a perfect hole, whenever, steel, cast iron, copper or plastic pipes pass through walls, ceilings or floors.

Material

Asbestos-free fibre cement, consisting of cement and glass-fibre, colour light grey. **Material class A1 according to DIN EN13501-1.**

Stability / characteristics

Corrosion resistant, **leak-proof against pressure water**, electrically insulating, non-inflammable, high stability, **good compound with concrete**, able to be coated, outer creasing circular, not helical, smooth inner walls, **high stability, split version** for subsequent assembly available, all lengths from **ND 80-800 sizes up to max. 1,200 mm available.**

Wall sleeves can either be set in concrete, walled in or built in a wall penetration with plaster, leak-proof.

Creasing on the outside offers **a water-proof compound with the building.** For usage in a concrete pool or container, the wall sleeve can be backed with a coating of the concrete construction. Function and compound of the wall sleeve with the concrete is certified by MFPA-Leipzig and **accredited up to 5 bar.**

In connection with our original PSI Link-Seal® or Kompakt seals, an absolute pressure water leak-proof sealing occurs in the annular space between the fibre cement wall sleeve and the casing pipe.

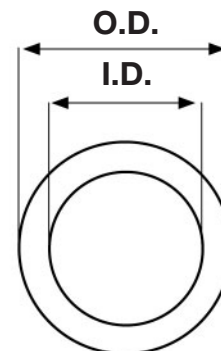

Technical data

Size	Dimensions		O.D. (in mm)
	I.D. (in mm)		
	Nominal size	Tolerance	
ND 80	80	+2/-1	120
ND 100	100	+2/-1	140
ND 125	125	+2/-1	165
ND 150	150	+2/-1	190
ND 200	201	+2/-1	250
ND 250	250	+2/-1	300
ND 300	300	+2/-1	350
ND 350	350	+2/-1	400
ND 400	400	+2/-1	460
ND 450	450	+2/-1	510
ND 500	500	+2/-1	570
ND 600	600	+3/-2	670
ND 700	700	+3/-2	780
ND 800	800	+3/-2	880

Technical changes are reserved, further sizes on request

Order description

Fibre-cement wall sleeve, ND size, length. Version closed/split. For split version additional putty is necessary. Available as a set with spacer, container at 1kg. Consumption about 125 gr. per 100mm sleeve length.



The complete inspection report is available at www.psi-products.de



ND Size	Length 200 mm		Length 250 mm		Length 300 mm		Length 350 mm	
	closed Art. no.	split Art. no.	closed Art. no.	split Art. no.	closed Art. no.	split Art. no.	closed Art. no.	split Art. no.
80	3-029-00050	3-029-00451	3-029-00051	3-029-00229	3-029-00052	3-029-01011	3-029-00506	3-029-01014
100	3-029-00100	3-029-00665	3-029-00120	3-029-01006	3-029-00140	3-029-00172	3-029-00152	3-029-01015
125	3-029-00101	3-029-01003	3-029-00121	3-029-00231	3-029-00141	3-029-00674	3-029-00215	3-029-01016
150	3-029-00102	3-029-00425	3-029-00122	3-029-00460	3-029-00142	3-029-00649	3-029-00409	3-029-00331
200	3-029-00103	3-029-00311	3-029-00123	3-029-00225	3-029-00143	3-029-00469	3-029-00153	3-029-01017
250	3-029-00104	3-029-00702	3-029-00124	3-029-00461	3-029-00144	3-029-00463	3-029-00154	3-029-01018
300	3-029-00105	3-029-01454	3-029-00125	3-029-00426	3-029-00145	3-029-00132	3-029-00158	3-029-01019
350	3-029-00106	3-029-01004	3-029-00126	3-029-01009	3-029-00146	3-029-00559	3-029-00159	3-029-01020
400	3-029-00107	3-029-01455	3-029-00127	3-029-00188	3-029-00147	3-029-00133	3-029-00156	3-029-01021
450	3-029-00108	3-029-00452	3-029-00128	3-029-00462	3-029-00148	3-029-01012	3-029-00179	3-029-01022
500	3-029-00109	3-029-01005	3-029-00129	3-029-00232	3-029-00149	3-029-00134	3-029-00138	3-029-01023
600	3-029-00110	3-029-01452	3-029-00130	3-029-00233	3-029-00150	3-029-00151	3-029-00332	3-029-01024
700	3-029-00111	3-029-01007	3-029-00131	3-029-00175	3-029-00137	3-029-00464	3-029-00139	3-029-01025
800	3-029-00504	3-029-01008	3-029-00505	3-029-01010	3-029-00366	3-029-01013	3-029-00367	3-029-01026

ND Size	Length 400 mm		Length 450 mm		Length 500 mm		Length 600 mm	
	closed Art. no.	split Art. no.	closed Art. no.	split Art. no.	closed Art. no.	split Art. no.	closed Art. no.	split Art. no.
80	3-029-00053	3-029-01027	3-029-00507	3-029-01034	3-029-00054	3-029-01048	3-029-00515	3-029-01055
100	3-029-00160	3-029-00439	3-029-00174	3-029-01035	3-029-00200	3-029-01049	3-029-00220	3-029-01056
125	3-029-00161	3-029-00020	3-029-00508	3-029-01036	3-029-00201	3-029-01050	3-029-00221	3-029-01057
150	3-029-00162	3-029-00703	3-029-00112	3-029-01037	3-029-00202	3-029-00454	3-029-00222	3-029-01058
200	3-029-00163	3-029-01028	3-029-00333	3-029-01038	3-029-00203	3-029-00472	3-029-00223	3-029-00289
250	3-029-00164	3-029-01029	3-029-00182	3-029-01039	3-029-00204	3-029-00465	3-029-00224	3-029-01059
300	3-029-00165	3-029-00557	3-029-00171	3-029-01040	3-029-00205	3-029-00455	3-029-00415	3-029-01060
350	3-029-00166	3-029-00556	3-029-00509	3-029-01041	3-029-00206	3-029-00458	3-029-00226	3-029-01061
400	3-029-00167	3-029-00176	3-029-00334	3-029-01042	3-029-00207	3-029-01051	3-029-00347	3-029-00157
450	3-029-00168	3-029-01030	3-029-00510	3-029-01043	3-029-00208	3-029-01052	3-029-00228	3-029-01062
500	3-029-00169	3-029-00219	3-029-00360	3-029-01044	3-029-00209	3-029-00471	3-029-00002	3-029-01063
600	029-00170	3-029-01031	3-029-00511	3-029-01045	3-029-00210	3-029-00315	3-029-00211	3-029-01064
700	3-029-00300	3-029-01032	3-029-00512	3-029-01046	3-029-00136	3-029-01053	3-029-00516	3-029-01065
800	3-029-00368	3-029-01033	3-029-00513	3-029-01047	3-029-00514	3-029-01054	3-029-00517	3-029-01066

ND Size	Length 700 mm		Length 800 mm		Length 1000 mm		Length 1200 mm	
	closed Art. no.	split Art. no.	closed Art. no.	split Art. no.	closed Art. no.	split Art. no.	closed Art. no.	split Art. no.
80	3-029-00518	3-029-01067	3-029-00524	3-029-01081	3-029-00528	3-029-01093	3-029-00529	3-029-01107
100	3-029-00519	3-029-01068	3-029-00234	3-029-01082	3-029-00260	3-029-01094	3-029-00530	3-029-01108
125	3-029-00281	3-029-01069	3-029-00282	3-029-01083	3-029-00261	3-029-01095	3-029-00650	3-029-01109
150	3-029-00252	3-029-01070	3-029-00343	3-029-01084	3-029-00262	3-029-01096	3-029-00359	3-029-01110
200	3-029-00411	3-029-01071	3-029-00344	3-029-01085	3-029-00263	3-029-01097	3-029-00424	3-029-01111
250	3-029-00435	3-029-01072	3-029-00345	3-029-00647	3-029-00264	3-029-01098	3-029-00324	3-029-01112
300	3-029-00247	3-029-01073	3-029-00346	3-029-01086	3-029-00265	3-029-00480	3-029-00531	3-029-01113
350	3-029-00520	3-029-01074	3-029-00115	3-029-01087	3-029-00266	3-029-01100	3-029-00532	3-029-01114
400	3-029-00406	3-029-01075	3-029-00436	3-029-01088	3-029-00267	3-029-01101	3-029-00422	3-029-01115
450	3-029-00521	3-029-01076	3-029-00525	3-029-00648	3-029-00268	3-029-01102	3-029-00533	3-029-01116
500	3-029-00253	3-029-01077	3-029-00419	3-029-01089	3-029-00269	3-029-01103	3-029-00534	3-029-01117
600	3-029-00254	3-029-01078	3-029-00278	3-029-01090	3-029-00270	3-029-01104	3-029-00615	3-029-01118
700	3-029-00522	3-029-01079	3-029-00526	3-029-01091	3-029-00271	3-029-01105	3-029-00535	3-029-01119
800	3-029-00523	3-029-01080	3-029-00527	3-029-01092	3-029-00272	3-029-01106	3-029-00536	3-029-01120

Further sizes on request

Attention, to be ordered as well:

Fibre cement kit adhesive compound for split/open wall sleeves, 1kg container	Art. no.
	3-029-00399

PSI Asbestos-Free Fibre Cement Wall Sleeve Installation Instruction



Warning:

The fibre cement wall sleeve can be obtained in every desired length (up to a maximum of 1,200 mm). Subsequent treatment is not required. If changes of the fibre cement wall sleeve are carried out on site, the following instructions have to be followed:

- Only hand-operated or slow running equipment with a dust collector should be used.
- Dust mask to be worn.
- Fibre cement only to be cut wet.
- Only to be worked with in the open air or well-ventilated rooms.
- Please pay attention to the valid Federal Dangerous Substances Regulation.
- The fine dust is harmful to health when inhaled.

Warning: insert the seal into the wall sleeve **after** the sleeve is casted into the concrete.

Fitting Instructions for PSI Fibre Cement Wall Sleeves, closed version

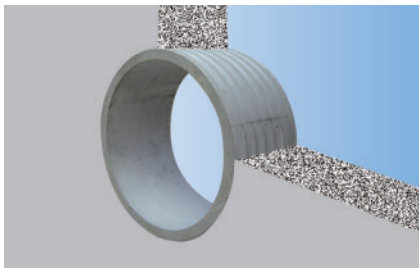

Fitting flush with casing or with casing supports

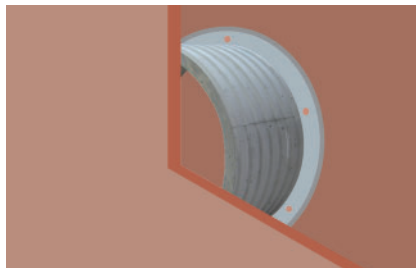

Fix wall sleeve in casing with casing supports



Fixing in steel casing welded with pipe clip (pipe clip on site)



Fitting in floor plate or ceiling



Fitting in brickwork

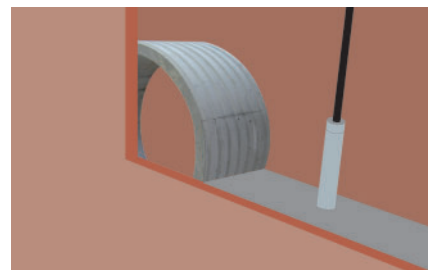

Thoroughly compress the concrete in the wall sleeve area.

Fitting Instructions for PSI Fibre Cement Wall Sleeves, split/open version

Warning: the processing instructions for the filler have to be followed

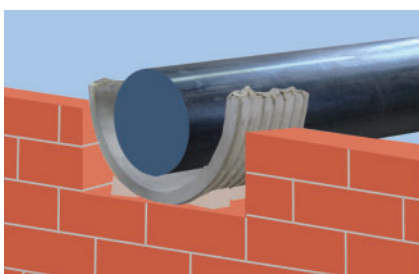

Align half casing to the carrier pipe



Fill in completely component B into filler (component A) and mix well.



Apply filler thickly to both half casings and press in spacer (included in the delivery) (distance to half casings 5 mm).



Connect half casings for fit until both halves rest on spacers.





Distribute filler evenly so that the inner surface forms a homogeneous seal surface, smooth with emery cloth, if necessary.

After a day's hardening time for the filler, the sleeve can be set in concrete.

Technical Data



PVC wall sleeves are suitable for setting in concrete or walling in. They are delivered in the standard 400 mm length and can be adapted to the wall thickness using a saw on site.

Description	Ø I.D. in mm	Ø O.D. in mm	length in mm	Art. no.
Wall sleeve PVC 	50	54	400	4-014- 22700
	60	65	400	4-014- 22701
	70	75	400	4-014- 22702
	80	85	400	4-014- 22703
	90	95	400	4-014- 22704
	100	106	400	4-014- 22705
	125	131	400	4-014- 22718
	150	160	400	4-014- 22707
	200	210	400	4-014- 22712
Reinforced wall thickness	82	90	400	4-014- 22708
	100	110	400	4-014- 22709
	250	280	400	4-014- 22711
 Wall sleeve with collar and lip-seal	Ø I.D. in mm	Ø Collar I.D. in mm	Length in mm	4-014- 22699
	100	110	500	

*Other lengths upon request

Accessories

 Wallsleeve mounting cap PE-LD	Ø I.D. PVC wall sleeve in mm	Art. no.
	60	on request
	80	on request
	100	4-014- 22713
	125	4-014- 22714
	150	4-014- 22715
	200	4-014- 22716
	250	4-014- 22717

Other dimensions upon request

Disclaimer

Please note, failure to select the correct materials or products we supply (“the Products”) may result in damage to plant, equipment or property. In some instances, it may cause death or personal injury. We are not designers and do not give advice about design related matters concerning the Products. We can help and assist with the technical specifications for the Products. In specific applications, particularly where critical conditions exist, we will try to assist you within the limitations of the services that we offer. All information supplied by us is intended as technical co-operation outlining the specifications of the different Products which we supply. To the extent permitted in law, no warranty is given in respect of any information supplied by us. The customer must satisfy themselves as to the suitability of the Products for their intended application and use. The correct fitting of Products is the responsibility of the customer. Your statutory rights remain unaffected. Save in respect of death, personal injury or fraud, our entire liability to you, however arising from the supply of Products shall be limited to the £10M indemnity amount provided by our insurers.